

The Influence of Cross-Section Shape of the Car Roof Rail on the Quasi-Dynamic Buckling Modes

Andrzej MRÓZ
*Faculty of Mechanical Engineering
Łódź University of Technology
Stefanowskiego 1/15, 90-924 Łódź, Poland
andrzej.mroz.pl@gmail.com*

Received (11 March 2013)

Revised (16 April 2013)

Accepted (20 Juni 2013)

This paper presents the results of numerical analysis of the aluminium profiles subjected to dynamic, of different time duration impulse loading. The analysis includes the change in cross-section of the roof rail, ranging from the open "C profile", through closed "Rectangular" to hybrid "Tandem with brackets". The main aim of this study is to model the dynamic response of the car roof rail to impulse loading, which may appear in case of collision.

Keywords: Aluminium, thin-walled profiles, automotive application, quasi-dynamic analysis

1. Introduction

Since the beginning of the automotive history, growing emphasis has been put on the development of the safety standards. Because of the continuous engine boosting, upgrading the power, efficiency and ecological standards – the modern cars are far different to their ancestors from the beginning of the 20th century. Adding to this the increasing number of used vehicles, there is a meaningful probability of various collisions.

Although before the pre-serial production the crash tests are carried through, these are realized in strictly precised conditions and are far from the parameters appearing in reality. Because of the high cost of destructive experiments, more and more attention is paid to computer analysis, basing mainly on FEM (Finite Element Method) software.

The author suggested the simplified analysis of the dynamic response of long, thin-walled profiles, which will be the introduction to complex study engaging the application for car roof rails. The aim of this is the verification of the influence of the

profile's cross-section (subjected to the dynamic impulse loading) and correctness of the statement treating the roof rails as safety upgrading equipment in car design.

1.1. *Literature review*

The stability of the thin-walled structures has been always in the main field of interest of many modern scientists. In the thirties of 20th century H. Wagner, H. L. Cox, K. Maguerre, E. Treffz, S. Levy, W.S. Hemp have initialized studies on post critical construction response in elastic range. Koning and Taub put the step further and examined the simply supported beam, subjected to axial impact [2]. This was the first analysis which because of the load time could be called as the pre-dynamic study. In the sixties, many publications describing the phenomenon of interaction of buckling modes and influence of initial imperfections have appeared.

Due to the technical development resulting in new invented materials and advanced computer facilities, a lot of analyses have been carried out, where not only the material properties have been taken into account but also specific initial conditions could have been modified. The item of A. Teter [3] is a very interesting example, where the dynamic, coupled buckling in long prismatic profile, simply supported at the ends is analyzed. Another publication, by Z. Kolakowski and T. Kubiak deals with the interactive dynamic buckling in thin walled channels made of orthotropic material subjected to in-plane pulse loading [4]. A meaningful attention should be paid to next items – a series of monographs where the problems of instability in the elasto-plastic range and post buckling behavior of plated structures are presented [5] and teamwork publication of the workers of Department of Strength of Materials of Lodz University of Technology, where among the literature and topic review, the examples of the dynamic stability analyses are presented [6].

1.2. *Dynamic buckling*

Dynamic stability (dynamic response) is the phenomenon of losing the stability of structures subjected to time-dependent impact. As mentioned in the literature review, the phenomenon of dynamic buckling of the structures has been started being investigated in the sixties. Since this time many criteria basing on geometrical or energetic assumptions have been developed. The most common are presented by Volmir [7], Budiansky–Hutchinson [8], Ari Gur and Simonetta [9], Petry Fahlbush [10].

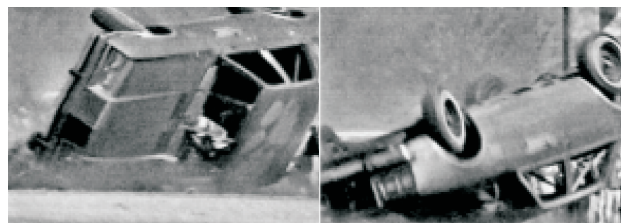

Figure 1 Illustration of highway rollover [1]

It is stated, that dynamic buckling appears in members subjected to impulse loading of certain time duration, close to the period of fundamental natural flexural vibrations. In the current article, the Budianski and Hutchinson criterion will be considered, that states: the dynamic stability loss occurs, when the maximum deflection grows rapidly at a small variation in the load amplitude.

2. Formulation of the problem

The rails – modeled as beams of the same length (600 mm), simply supported at the ends but of different cross-section shapes are taken into consideration. Thus, the "C channel" presented in Fig. 2a, "Rectangular" Fig. 2b, hybrid ones "Internal Tandem" Fig. 2c and "External Tandem" Fig. 2d are within this paper interest. The dimensions of the profile are modified in a way, to achieve the same value of perimeter (cross-section area).

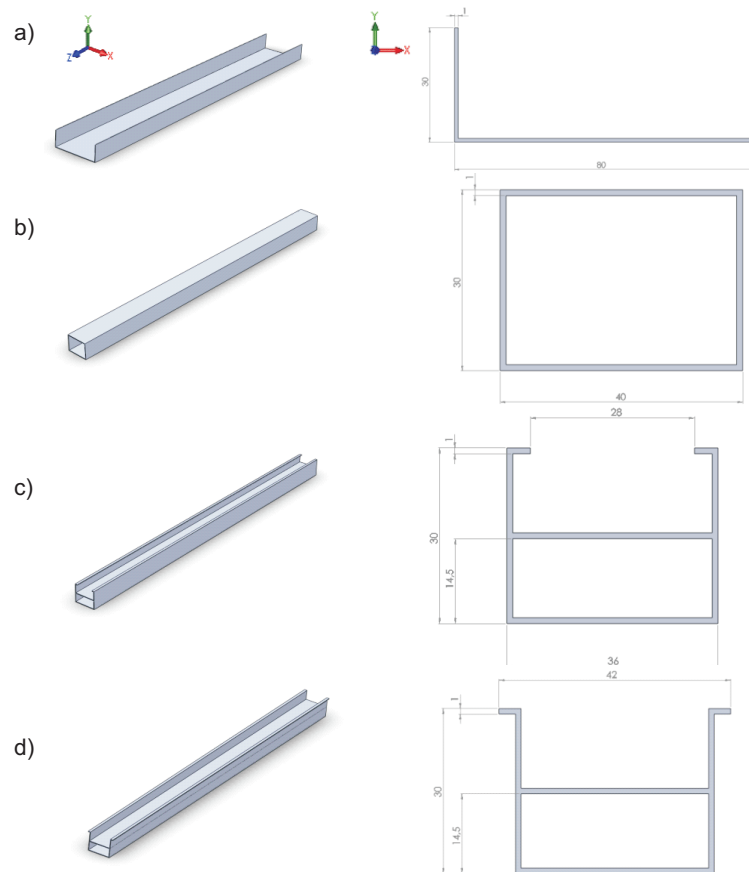

Figure 2 Considered cross-sections of the profile with dimensions: a) C channel, b) Rectangular, c) Internal tandem, d) External tandem

The profiles are made of isotropic, linear elastic material - aluminium alloy 6060 which mechanical properties are presented in Table 1.

Table 1 Mechanical properties of aluminium alloy 6060 [11]

| Density [g/cm ³] | Melting range [°C] | Modulus of elasticity [MPa] | Shear modulus [MPa] |
|---------------------------------|-----------------------|--------------------------------|------------------------|
| 2,7 | 585-650 | 69 500 | 26 100 |

The profiles/rails are subjected to axial uniform compression σ_{zimp} on one end with the another constrained. The time duration of the impulse varies from 0.5 to 1.0 of natural period T_{np} (Fig. 3).

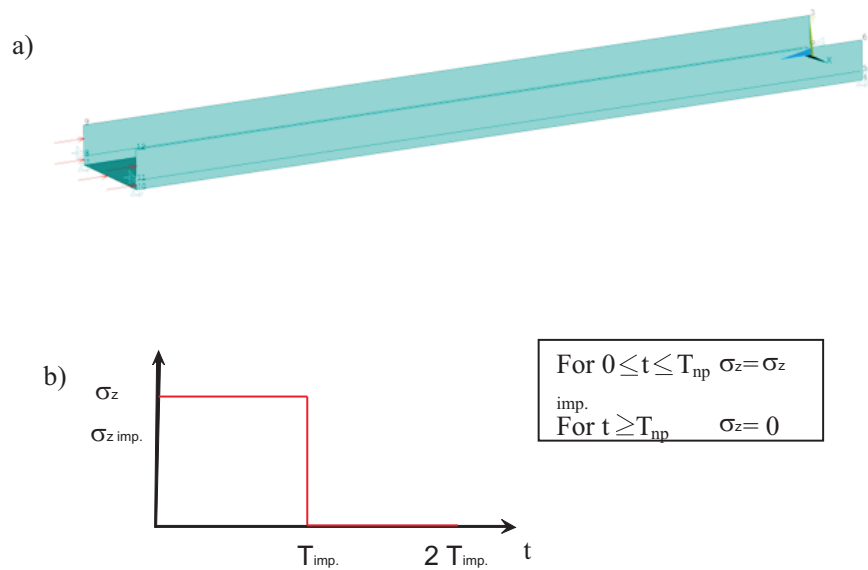

Figure 3 Loading details: a) C channel boundary conditions, b) The rectangular impulse loading characteristics

3. Results of numerical analysis

The results of numerical computations are the evidence of meaningful influence of the profile cross-section shape on its natural fundamental frequencies (presented in Fig. 4.) and critical stress value (Fig. 5). This is especially distinctive when comparing the value of critical stress of the open "C-channel" to the rectangular

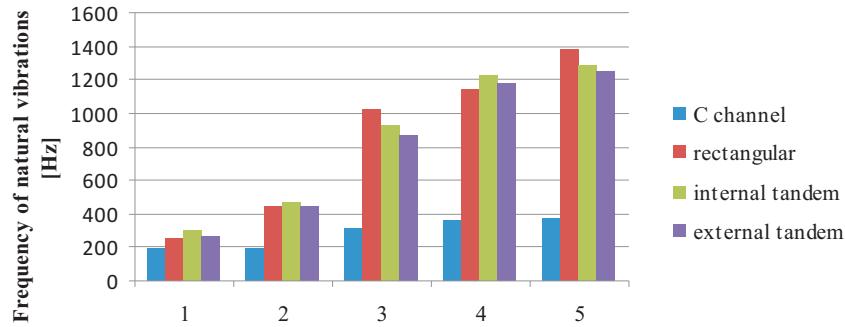

Figure 4 First 5 lowest natural frequencies for the beams of different cross-sections

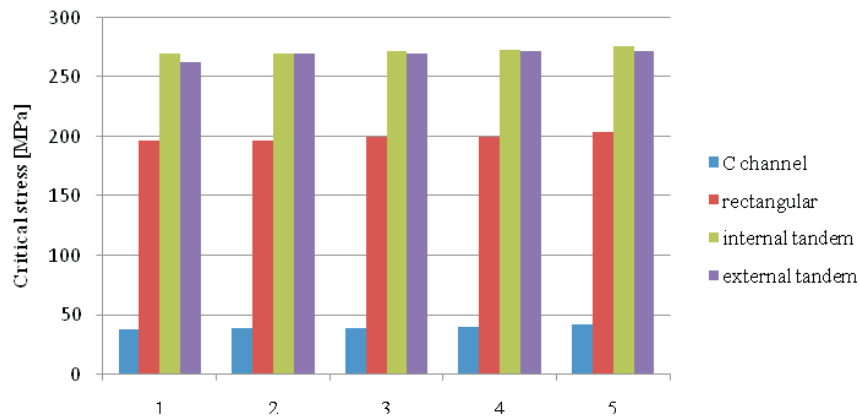

Figure 5 First 5 lowest values of critical stress for the axially compressed beams of different cross-sections

profile critical stress. The closed cross-section brings the increase of critical stress more than 5 times. The hybrid solution of the cross-section is a way to improve the rail stability by 30%. However there is no distinct distortion between internal and external tandem.

When taking into consideration the transient – dynamic analysis, the critical value of Dynamic Load Factor is on comparable order of magnitude for both compared profiles. The buckling modes are presented in Fig. 6 where the graphs presenting the dependence between DLF and deflection in Internal Tandem, for different impact duration are presented in Fig. 7 and Fig. 8.

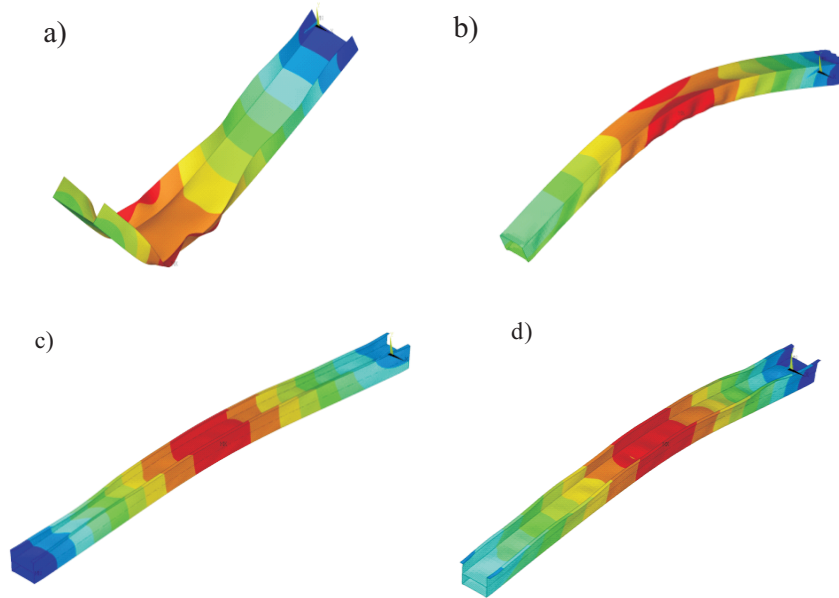

Figure 6 Dynamic response to impulse compression pressure of the profile with cross section: a) C channel, b) Rectangular, c) Internal tandem, d) External tandem

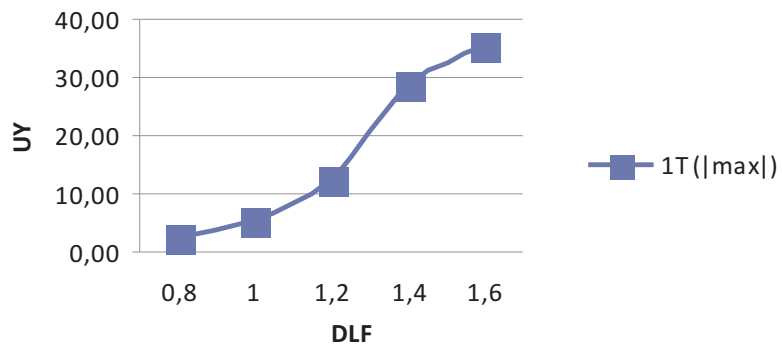

Figure 7 Dynamic deflection obtained with the FEM for Internal tandem- time duration of compression impulse equals 1 x natural period (of 1st mode)

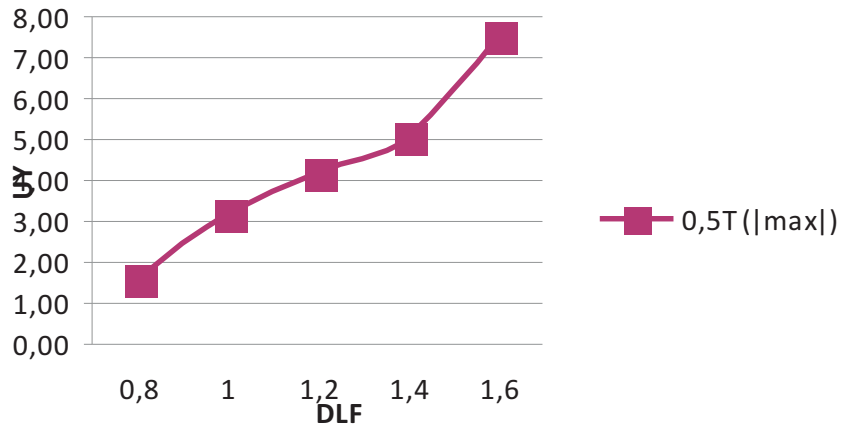

Figure 8 Dynamic deflection obtained with the FEM for Internal tandem- time duration of compression impulse equals 0.5 x natural period (of 1st mode)

The deflection was determined for displacement in perpendicular to the mid-plane for the same node for all types of the profiles. The duration of the pulse load plays a fundamental role on the buckling character. For long lasting impulse (1 Tnp) the magnitude of the displacement is almost 5 times higher than for the load lasting of 0.5 Tnp. The value of the critical DLF is comparable, however for the shorter impact, it is almost 8% higher. The results for all profiles are presented in Tab. 2.

Table 2 Determined Dynamic Load Factor for different cross-sections

| | C channel | Rectangular | Internal tandem | External tandem |
|--|-----------|-------------|-----------------|-----------------|
| time duration of compression impulse equals 1 x natural period | 1,5 | 1,4 | 1,3 | 1,1 |
| time duration of compression impulse equals 0.5 x natural period | 1,6 | 1,8 | 1,4 | 1,4 |

4. Conclusion

The article is the introduction of the author’s involvement in dynamic stability of the roof rails in automotive application. The proposed numerical model was consciously simplified in order to investigate the influence of the beam’s cross-section shape on the dynamic stability and the obtained results confirmed the initial statement.



Figure 9 Rollover crash test of Volvo XC90 [7]

The next steps which will be taken, will concern the correlation between the natural frequencies and buckling mode in order to characterize the appropriate pulse duration and to make the phenomenon more "dynamic". Moreover, the shape of the impulse will be modified in order to make it more realistic to the ones occurring during the crash (records from decelerator meters from crash test).

In addition to this, nonlinear material characteristics – achieved from laboratory tensile test, will be considered and the aging process of the aluminium will be taken into account and modeled in FEM analysis.

References

- [1] **Eichler, R. C.:** The causes of injury in rollover accidents, *Accident Reconstruction Journal*, **2003**.
- [2] **Koning, C. and Taub, J.:** Impact buckling of thin bars in the elastic range hinged at both ends, *NACA TM*, 748, 1934.
- [3] **Teter, A.:** Wielomodalne wyoboczenie cienkościennych uebrowanych słupów obciążonych impulsem ściskającym, *Wydawnictwo Politechniki Łódzkiej*, Łódź, (in polish), **2010**.
- [4] **Kołakowski, Z. and Kubiak, T.:** Interactive dynamic buckling of orthotropic thin-walled channels subjected to in-plane pulse loading, *Composite Structures*, 81, 222–232, **2007**.
- [5] **Kowal–Michalska, K. (Ed.):** Dynamic Stability of Composite Plate Structures, *WNT*, Warszawa, **2007**.
- [6] **Królak, M. and Mania, R. J. (Eds.):** Stability of Thin-Walled Plate Structures, Vol.1 of Static, Dynamic and Stability of Structures, A Series of Monographs, *TUL*, **2011**.
- [7] <http://auto.howstuffworks.com/car-driving-safety/accidents-hazardous-conditions/28002-rollover-accidents-explained.htm>