

VIBRATIONAL ENERGY TRANSFER VIA MODULATED IMPACTS FOR PERCUSSIVE DRILLING

MARIAN WIERCIGROCH

*University of Aberdeen, Centre for Applied Dynamics Research, Aberdeen, Scotland, UK
e-mail: m.wiercigroch@abdn.a.uk*

ANTON M. KRIVTSOV

*St.-Petersburg State Technical University, Department of Theoretical Mechanics, St.-Petersburg,
Russia*

JERZY WOJEWODA

Technical University of Lodz, Division of Dynamics, Łódź, Poland

In this paper, a new method of vibrational energy transfer from high-frequency low-amplitude to low-frequency high-amplitude mechanical vibrations is proposed and investigated, for the purpose of percussive drilling. The mechanism uses an impact loading comprised of two frequencies forming a beat which excites a structure tuned to the beat-frequency. This concept has been modelled and experimentally verified. It is postulated that the efficiency of this technique is strongly dependent on the strength of nonlinearity in the system. The vibrational energy transfer is significantly reduced for superharmonic responses of the system. Practical applications of this mechanism can be seen as new generation percussive drilling tools.

Key words: vibration, energy transfer, impacts, experimental studies

1. Introduction

This work was inspired by the project funded by The Centre for Marine and Petroleum Technology entitled 'Enhanced Resonance Drilling' (Wiercigroch, 1999), which was intended to ascertain the extent to which an introduction of high frequency loading can improve drilling rates and reduce drilling forces, in particular, the weight-on-bit (WOB). This was accomplished by carrying out experimental studies in the laboratory on a carefully chosen selection of the

rocks most likely to be encountered while drilling in the North Sea (Wiercigroch *et al.*, 2005).

The studies performed so far have confirmed that the percussive drilling has a very clear advantage of achieving much higher drilling rates (up to 10 times) (Krivtsov and Wiercigroch, 1999; Wiercigroch *et al.*, 1999, 2000) whilst compared to the traditional shearing type drilling. It has to be noted here that these results were obtained for a small-scale rig under conditions which differ from the typical downhole ones. These high drilling rates are achieved for the resonance conditions, which vary with respect to different rocks.

It is clear that the presented idea of transferring high-frequency low-amplitude vibrational energy to low-frequency high-amplitude will have much wider and generic applications. In fact, there are already some initial studies (Anderson *et al.*, 1996; Tabaddor and Nayfeh, 1997) addressing the issue of high and low frequency modal interactions. The reported energy transferred is modest due to weak nonlinearities in the system transferring energy.

The aim of this paper is to prove a novel concept of transferring vibrational energy via impact (percussive) loading, which can be applied to the percussive downhole drilling. The basic idea originates from the experimental and theoretical studies on impact oscillators (Natsiavas, 1998, 1990; Peterka and Vacik, 1992; Pavlovskaja and Wiercigroch, 2003a,b, 2004; Pavlovskaja *et al.*, 2001, 2003; Wiercigroch and Sin, 1998), which are strongly nonlinear. The main nonlinearity in impact oscillators comes from the discontinuity in the governing equation at the moment of impact. It is postulated here that strong nonlinearity creates necessary conditions for efficient energy transfer.

This paper is organised as follows. Section 2 presents the results of experimental studies for a beam system. Section 3 contains a mathematical description and analysis of the experimental rig. In Section 4, an averaging procedure was applied to obtain an approximate analytical model. The analytical solution is used to compute amplitude-frequency curves for a single, harmonic and beat excitation. In Section 5, we draw some conclusions.

2. Experimental study

The experimental study presented here is to verify the proposed concept of the vibrational energy transfer. Transforming a beatwise excitation into a single frequency response was achieved by using a simple cantilever beam system. The beam has an end mass to control the first natural frequency and to amplify

the lateral displacement whilst operating in the resonant mode. It is excited from a vibration exciter by an extension rod located close to the support of the beam. This arrangement guarantees generation of hard impacts.

The excitation from the shaker is in the form of impacts shaped as a beat forcing, $x(t)$, as depicted in Fig. 1. Two harmonic signals of the same amplitude and having a frequency difference equal to the beat frequency are summed up together to obtain a beat excitation as shown in the upper panel of Fig. 2. Then the beat signal is amplified and sent to the vibration exciter, which impacts the beam with a beatwise pattern.

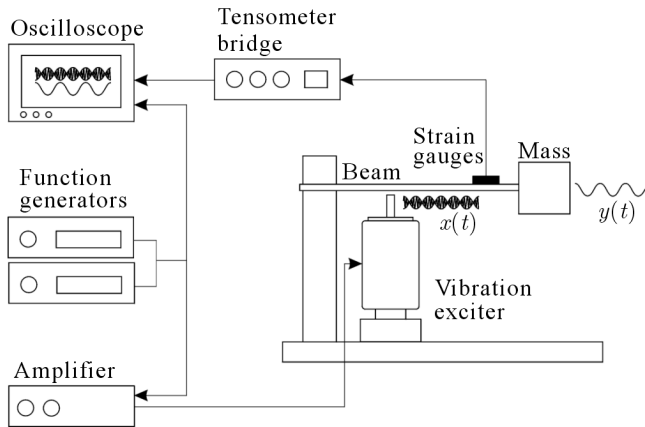

Fig. 1. Experimental beam system

As mentioned earlier, the first natural frequency of the beam system is chosen to match the beat-frequency. The gap between the beam at motion is only a small fraction (a few percent) of the end mass motion amplitude. To monitor the lateral vibration of the beam $y(t)$, a pair of strain gauges arranged in a half bridge was used. The time history recorded from the strain gauges is given in the lower part of Fig. 2. As can be seen, the beam system responds well to the high-frequency beat excitation.

The amplitude-frequency curve (AFC) have been obtained experimentally by varying the excitation frequency and recording the amplitude of the dynamic response. Figure 3 compares the amplitude of the system responses for the single frequency and beat excitation impacts modes. Apart from the main resonance, the $1/2$ and $1/3$ superharmonics are clearly visible for both types of excitation. It is worth noting that when exciting with beat impacts, a large amount of vibrational energy is transferred. By comparing the amplitudes for the single and beat-frequency impact excitations at the main resonance, approximately seventy percent of the single frequency response is obtained for

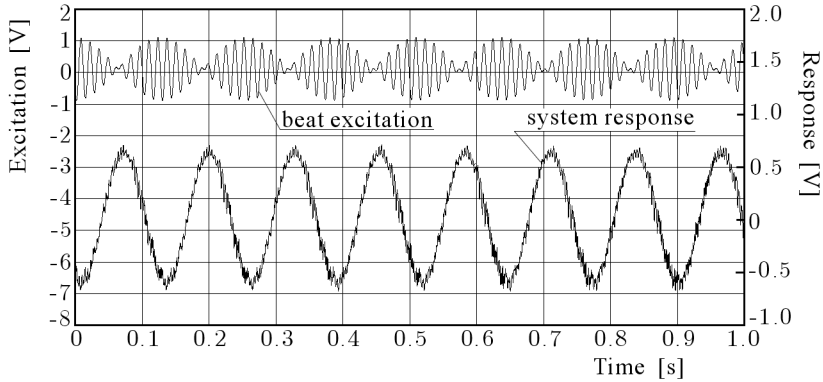

Fig. 2. Beat-wise excitation (upper plot) and the end mass response (lower plot)

the beat loading. The transfer is significantly reduced for the superharmonic responses. To obtain a better insight of the system dynamics, a robust mathematical modelling and analysis is needed, and this is undertaken in the next Section.

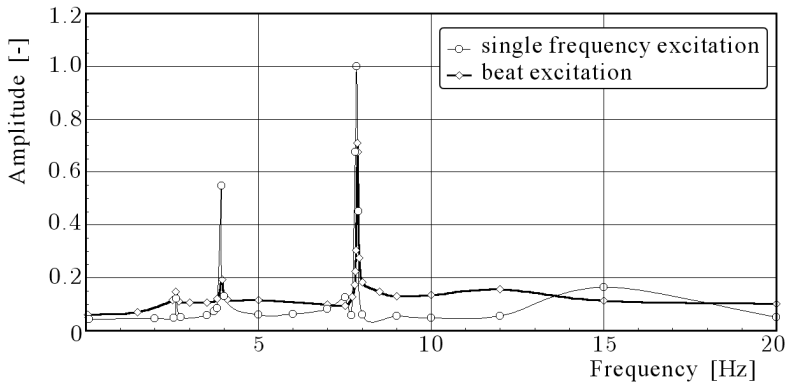

Fig. 3. Experimental amplitude-frequency plot

3. Modelling and analysis

Consider a conceptual model presented in Fig. 4, where x is the displacement of the mass m , which is expected to vibrate with a low frequency and high amplitude; y is the displacement of the exciter vibrating with a high frequency and low amplitude, where z is the displacement of the massless plate P , which

is being impacted by the exciter head. The oscillations are then transferred to the mass m . The plate is connected to the support by a short spring c_1 and to the mass with a long spring c_2 , where $c_1 \gg c_2$. The difference in the length of the springs allows one to obtain a high amplitude vibration of the mass while the plane is vibrating with a low amplitude. The displacements y and z are measured from the same position determined by the initial length of the spring c_2 . The displacement x is measured from the right tip of the spring c_2 at the initial state of the springs.

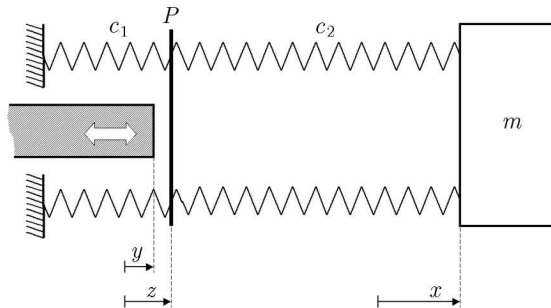

Fig. 4. A physical model for beat-frequency vibrational energy transfer

Let us denote the equivalent stiffness of the springs c_1 and c_2 as c , which for a parallel spring connection is

$$c = \frac{c_1 c_2}{c_1 + c_2} \tag{3.1}$$

When the plate P is not in contact with the exciter, then its displacement can be calculated as

$$z = \frac{c}{c_1} x = \alpha x \quad \alpha \ll 1 \tag{3.2}$$

where α is a small parameter due to the mentioned above differences in the spring stiffnesses. Then the equation of motion for the mass m can take the following piecewise linear form

$$\begin{cases} y \leq \alpha x : & m\ddot{x} + cx = 0 \\ y \geq \alpha x : & m\ddot{x} + c_2(x - y) = 0 \end{cases} \tag{3.3}$$

Hence, there are two equations of motion; the first one is applicable when the exciter is not in contact with the plate ($y < \alpha x$), the second one is for the contact case ($y \geq \alpha x$). It can be easily shown that when $y = z_0$, both

equations are identical. Expressing c_2 in terms of c and α , one can rewrite the second equation as

$$m\ddot{x} + cx = \frac{c}{1-\alpha}(y - \alpha x) \quad (3.4)$$

which allows one to rewrite system (3.3) as a single equation

$$\ddot{x} + k^2x = \frac{k^2}{1-\alpha}\mathcal{P}(y - \alpha x) \quad (3.5)$$

where $k = \sqrt{c/m}$ is the natural frequency of the system; $\mathcal{P}(\zeta)$ is a switch function defined as

$$\mathcal{P}(\zeta) = \begin{cases} 0 & \text{for } \zeta \leq 0 \\ \zeta & \text{for } \zeta \geq 0 \end{cases} \quad (3.6)$$

4. Approximation and averaging

Assume that the exciter is oscillating harmonically according to the formula

$$y = y(t) = A(t) \sin(\Omega t) - s \quad \Omega \gg k \quad (4.1)$$

where Ω represents the high (excitation) frequency, s – gap between the exciter head and the plate, $A(t)$ – amplitude of the high frequency oscillations, carrying low frequency oscillations. For beat oscillations $A(t) = A_0 \sin(\omega t/2)$, the beat excitation is depicted in Fig. 5, where A_0 is the amplitude, ω is the low frequency. Here, the influence of the oscillating system on the exciter is neglected. Let us average Eq. (3.5) over a period τ of the high frequency oscillations, $\tau = 2\pi/\Omega$

$$\langle \ddot{x} \rangle + k^2 \langle x \rangle = \frac{k^2}{1-\alpha} \langle \mathcal{P}(y - \alpha x) \rangle \quad (4.2)$$

where

$$\langle \zeta \rangle = \frac{1}{\tau} \int_0^\tau \zeta dt$$

The displacement of the mass can be represented as a sum of two components

$$x = X + \xi \quad X = \langle x \rangle \quad (4.3)$$

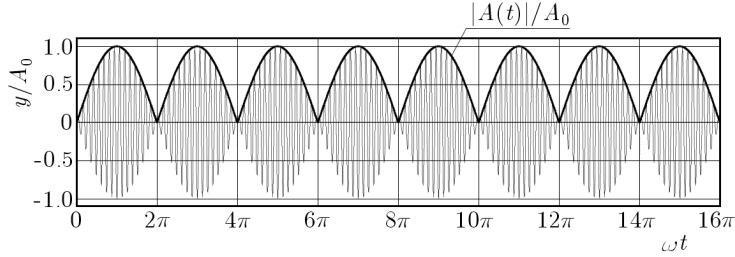

Fig. 5. Beat excitation

where X is the low frequency high amplitude component, and ξ is the high frequency low amplitude component.

For $\alpha \ll 1$ and $\xi \ll X$, the $\alpha\xi$ term can be neglected, which leads to

$$\langle \mathcal{P}(y - \alpha X - \alpha\xi) \rangle \approx \langle \mathcal{P}(y - \alpha X) \rangle \tag{4.4}$$

Now let us evaluate expression (4.4)

$$\langle \mathcal{P}(y - \alpha X) \rangle = \frac{|A(t)|}{\tau} \int_0^\tau \mathcal{P}(\pm \sin(\Omega t) - q) dt \quad q = \frac{s + \alpha X}{|A(t)|} \tag{4.5}$$

where "±" is the sign of $A(t)$. It here is assumed that the low frequency function $A(t)$ does not change over the short period of time τ . The above integral can be represented as

$$\langle \mathcal{P}(y - \alpha X) \rangle = |A(t)| I(q) \tag{4.6}$$

where

$$I(q) = \frac{1}{2\pi} \int_0^{2\pi} \mathcal{P}(\sin \theta - q) d\theta \quad \theta = \Omega t$$

The sign "±" can be omitted here because it does not have any influence on the value of the integral. The integral $I(q)$ is calculated as

$$\begin{cases} q \leq -1 & \Rightarrow I(q) = -q \\ -1 \leq q \leq 1 & \Rightarrow I(q) = \frac{1}{\pi} \left(\sqrt{1 - q^2} - q \arccos q \right) \\ 1 \leq q & \Rightarrow I(q) = 0 \end{cases} \tag{4.7}$$

and shown in Fig. 6.

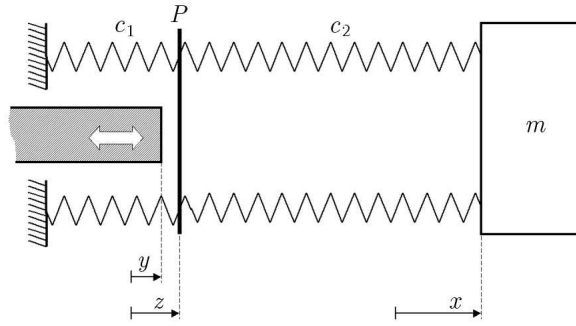

Fig. 6. Function $I(q)$

Finally, by substituting (4.3), (4.4) and (4.6) to (4.2), one can obtain an equation for the slow component X of the mass motion in the form

$$\ddot{X} + k^2 X = k^2 G(X, t) \tag{4.8}$$

where $k^2 G(X, t)$ is the excitation force defined by

$$G(X, t) = \frac{|A(t)|}{1 - \alpha} I\left(\frac{s + \alpha X}{|A(t)|}\right) \tag{4.9}$$

The function $I(q)$ is shown in Fig. 6 and determined from (4.7). The function $G(X, t)$ can be understood as an equivalent forcing of a simple oscillator depicted in Fig. 7, whose its dynamics is governed by (4.8).

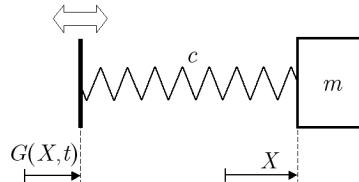

Fig. 7. Model corresponding to the averaged equation

Consider now averaged equation (4.8) for the simplest case: $\alpha \rightarrow 0, s = 0$. Here $G(X, t)$ is directly proportional to $|A(t)|$

$$G(X, t) = |A(t)| I(0) = \frac{1}{\pi} |A(t)| \tag{4.10}$$

Let us assume $A(t) = A_0 \sin(\omega t/2)$, where A_0 is a constant, ω is the low excitation frequency. This corresponds to the following beat excitation:

$y(t) = A_0 \sin(\omega t/2) \sin(\Omega t)$, where Ω is the high frequency (see Fig. 5). Equation of motion (4.8) takes the following form in this case

$$\ddot{X} + 2\beta\dot{X} + k^2X = k^2 \frac{A_0}{\pi} \left| \sin \frac{\omega t}{2} \right| \tag{4.11}$$

To represent the system more adequately, a viscous damping is added to (4.8), where the damping coefficient is a small parameter, $\beta \ll k$. The computed amplitude-frequency characteristic (AFC) is depicted in Fig. 8, from which it can be deduced that the main resonance occurs for $\omega = k$. This is due to the fact that if one takes the absolute value of $\sin(\omega t/2)$, then the main frequency increases twice. In addition, the AFC in Fig. 8 has clear superharmonic resonances, corresponding to $\frac{1}{2}, \frac{1}{3}, \frac{1}{4}, \frac{1}{5}, \dots$ of the main resonance frequency. These resonances are the result of the non-harmonic form of the excitation force.

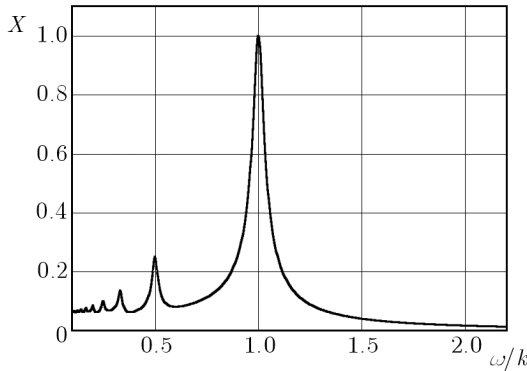

Fig. 8. Amplitude frequency characteristic

To show better the nature of the superharmonic resonances, let us expand the right part of equation (4.11) into Fourier series

$$\left| \sin \frac{\omega t}{2} \right| = \frac{2}{\pi} - \frac{4}{\pi} \sum_{n=1}^{\infty} \frac{\cos n\omega t}{4n^2 - 1} \tag{4.12}$$

For a small dissipation, the resonance amplitudes are proportional to the expansion coefficients, which means that the subharmonic resonance amplitudes are decreasing with $1/n^2$.

To assess the efficiency of the beat frequency excitation mechanism, a comparison with the low frequency excitation $y = A_0 \sin \omega t$ is made. In this case, equation of motion (3.5) takes the form

$$\ddot{X} + 2\beta\dot{X} + k^2X = k^2 A_0 \mathcal{P}(\sin \omega t) \tag{4.13}$$

where $X \equiv x$ due to absence of the high frequency component. By analysing Fig. 9, one can easily deduce that the beat mechanism can effectively 'pump' approximately a quarter of the energy transferred via the single frequency impact excitation, which is approximately twelve times more than previously reported.

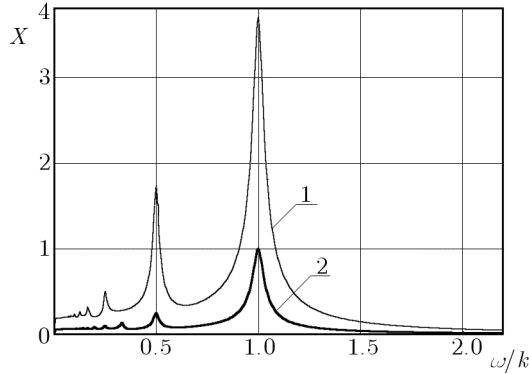

Fig. 9. Comparison of AFC for single frequency excitation (1) and beat excitation (2)

The expansion of the right-hand sides of equations (4.11) and (4.13) into the Fourier series retaining only two main terms gives

$$\left| \sin \frac{\omega t}{2} \right| \approx \frac{2}{\pi} - \frac{4}{3\pi} \cos \omega t \quad \mathcal{P}(\sin \omega t) \approx \frac{1}{\pi} + \frac{1}{2} \sin \omega t \quad (4.14)$$

where the coefficients with $\cos \omega t$ and $\sin \omega t$ are responsible for the main resonance. Thus the ratio between the main resonance amplitudes in these two cases is equal to $3\pi/8 \approx 3.70$.

5. Closing remarks

In this paper, the proposed vibrational energy transfer mechanism from high-frequency low-amplitude to low-frequency high-amplitude mechanical vibrations has been investigated experimentally and theoretically. The mechanism uses an impact loading comprised of two frequencies forming a beat, which excites a structure tuned to the beat-frequency. The best efficiency is obtained for the main resonance, for which a large amount of energy can be transferred. The transfer is significantly reduced for the superharmonics. It is also postulated throughout the paper that the efficiency of this technique is strongly dependent on the strength of nonlinearity in the system.

Although all precautions have been taken to ensure the same parameters and conditions as for the theoretical model, there is no guarantee that the coefficient of damping and the gap were the same. The obtained results confirmed that the proposed impact beat mechanism can be effective in energy transfer.

The authors would like to kindly acknowledge financial support from the Royal Society of London and from the Centre for Marine and Petroleum Technology.

References

1. ANDERSON T.J., NAYFEH A.H., BALACHANDRAN B., 1996, Coupling between high-frequency modes and a low-frequency mode: Theory and experiment, *Nonlinear Dynamics*, **11**, 1, 17-36
2. KRIVTSOV A.M., WIERCIGROCH M., 1999, Dry friction model of percussive drilling, *Meccanica*, **34**, 6, 425-434
3. NATSIAVAS S., 1998, Stability of piecewise linear oscillators with viscous and dry friction damping, *Journal of Sound and Vibration*, **217**, 3, 507-522
4. NATSIAVAS S., 1990, Stability and bifurcation-analysis for oscillators with motion limiting constraints, *Journal of Sound and Vibration*, **141**, 1, 97-102
5. PAVLOVSKAIA E.E., WIERCIGROCH M., 2003a, Modelling of vibro-impact system driven by beat frequency, *International Journal of Mechanical Sciences*, **45**, 4, 623-641
6. PAVLOVSKAIA E.E., WIERCIGROCH M., 2003b, Periodic solutions finder for an impact system with a drift, *Journal of Sound and Vibration*, **267**, 4, 893-911
7. PAVLOVSKAIA E.E., WIERCIGROCH M., 2004, Analytical drift reconstruction for an impact system operating in periodic and chaotic regimes, *Chaos, Solitons and Fractals*, **19**, 1, 151-161
8. PAVLOVSKAIA E.E., WIERCIGROCH M., GREBOGI C., 2001, Modelling of an impact oscillator with a drift, *Physical Review E*, **64**, 056224
9. PAVLOVSKAIA E.E., WIERCIGROCH M., WOO K.-C., RODGER A.A., 2003, Modelling of a vibro-impact ground moling system by an impact oscillator with a frictional slider, *Meccanica*, **38**, 1, 85-97
10. PETERKA F., VACIK J., 1992, Transition to chaotic motion in mechanical systems with impacts, *Journal of Sound and Vibration*, **154**, 1, 95-115

11. TABADDOR M., NAYFEH A.H., 1997, An experimental investigation of multimode responses in a cantilever beam, *Journal of Vibration and Acoustics-Transactions of the ASME*, **119**, 4, 532-538
12. WIERCIGROCH M., 1999, Enhanced Resonance Drilling Report from CMPT Research, Grant No. PMF008/CMPT Pathfinder
13. WIERCIGROCH M., KRIVTSOV A.M., WOJEWODA J., 2000, Dynamics of Ultrasonic, In: *Applied Nonlinear Dynamics and Chaos of Mechanical Systems with Discontinuities*, edit. Wiercigroch M. and Kraker B., World Scientific, 403-444
14. WIERCIGROCH M., NEILSON R.D., PLAYER M.A., 1999, Material removal rate prediction for ultrasonic drilling of hard materials using an impact oscillator approach, *Physics Letters A*, **259**, 2, 91-96
15. WIERCIGROCH M., SIN V.T.W., 1998, Experimental study of based excited symmetrically piecewise linear oscillator, *Journal of Applied Mechanics*, **65**, 657-663
16. WIERCIGROCH M., WOJEWODA J., KRIVTSOV A., 2005, Dynamics of percussive drilling of hard rocks, *Journal of Sound and Vibration*, **280**, 3/5, 739-757

Transfer energii drgań poprzez modulowanie uderzeń w wierceniu udarowym

Streszczenie

W niniejszej pracy zaproponowano i pokazano wyniki nowego sposobu transferu energii z obszaru drgań o wysokich częstościach i małych amplitudach w obszar niskich częstości i dużych amplitud. Badania przeprowadzone były pod kątem zastosowań w wierceniu udarowym. Mechanizm działania wykorzystuje obciążenie uderzeniami modulowane kombinacją dwu częstości tworzących obwiednię w kształcie dudnienia o strukturze dostrojonej do częstości uderzeń. Pokazano opracowany model i wyniki jego weryfikacji eksperymentalnej. Wydaje się, że wydajność tej techniki jest mocno zależna od siły nieliniowości w układzie. Transfer energii drgań jest mocno zmniejszony dla superharmonicznych odpowiedzi układu. Możliwe jest praktyczne zastosowanie tego mechanizmu w nowej generacji wiertel udarowych.

Manuscript received November 8, 2007; accepted for print December 5, 2007